



# 2022 Hanger Range



RETAIL ACCESSORIES

ISSUE 08 / 2022

# Partnering with Pact Reuse Retail Accessories (Formerly TIC)

Since 1989, Pact Reuse Retail Accessories has been working with top global fashion retailers to pioneer a world-first reuse model. In over 30 years, we've grown our footprint consistently on the basis of superior service and a global reuse platform that allows our partners to achieve reuse rates of over 80% in many cases.

Today, Pact Reuse Retail Accessories reuses over 1 billion hangers per year, servicing a network of more than 2,500 garment manufacturers and over 8,000 retail stores across the globe.

We thank you for entrusting Pact Reuse Retail Accessories to deliver sustainable solutions for your business.

# Index - page 1

CHILDRENS TOPS	
CODE	TC22CG6
DESCRIPTION	Top Hanger
SIZE	220mm
COLOUR	Cool Grey
CODE	TC26CG6
DESCRIPTION	Top Hanger
SIZE	260mm
COLOUR	Cool Grey
CODE	TC30CG6
DESCRIPTION	Top Hanger
SIZE	300mm
COLOUR	Cool Grey
CODE	TC36CG6
DESCRIPTION	Top Hanger
SIZE	360mm
COLOUR	Cool Grey
CODE	TC41CG6
DESCRIPTION	Top Hanger
SIZE	410mm
COLOUR	Cool Grey
CHILDRENS BOTTOMS	
CODE	PC19CG6
DESCRIPTION	Prong Bottom Hanger
SIZE	190mm
COLOUR	Cool Grey
CODE	PC19LCG6
DESCRIPTION	Prong Bottom Hanger with Loop
SIZE	190mm
COLOUR	Cool Grey
CODE	PC26CG6
DESCRIPTION	Prong Bottom Hanger
SIZE	260mm
COLOUR	Cool Grey
CODE	PC26LCG6
DESCRIPTION	Prong Bottom Hanger with Loop
SIZE	260mm
COLOUR	Cool Grey
CODE	BC22FCCG6
DESCRIPTION	Bottom Fixed Clip Hanger
SIZE	220mm
COLOUR	Cool Grey
CODE	BC25FCCG6
DESCRIPTION	Bottom Fixed Clip Hanger
SIZE	250mm
COLOUR	Cool Grey
CODE	BC28FCCG6
DESCRIPTION	Bottom Fixed Clip Hanger
SIZE	280mm
COLOUR	Cool Grey

CHILDRENS SPECIALITY	
CODE	DTC26CG6
DESCRIPTION	Top Double Hangers
SIZE	260mm
COLOUR	Cool Grey
CODE	DTC30CG6
DESCRIPTION	Top Double Hangers
SIZE	300mm
COLOUR	Cool Grey
CODE	DTC36CG6
DESCRIPTION	Top Double Hangers
SIZE	360mm
COLOUR	Cool Grey
CODE	TH41DS3CG6
DESCRIPTION	Top Triple Hanger
SIZE	300mm
COLOUR	Cool Grey
CODE	TH42DS3CG6
DESCRIPTION	Top Triple Hanger
SIZE	350mm
COLOUR	Cool Grey
CODE	TC210-2CG6
DESCRIPTION	2 Arm Top Hanger
SIZE	210mm
COLOUR	Cool Grey
CODE	TC210-3CG6
DESCRIPTION	3 Arm Top Hanger
SIZE	210mm
COLOUR	Cool Grey
CODE	TC210-5CG6
DESCRIPTION	5 Arm Top Hanger
SIZE	210mm
COLOUR	Cool Grey

# Index - page 2

LADIES TOPS	
CODE	TC41CG11
DESCRIPTION	Top Hanger
SIZE	410mm
COLOUR	Charcoal Grey
CODE	TC46CG11
DESCRIPTION	Top Hanger
SIZE	460mm
COLOUR	Charcoal Grey
CODE	KU41CG11
DESCRIPTION	Knitwear Hanger
SIZE	410mm
COLOUR	Charcoal Grey
CODE	JUM38CG11
DESCRIPTION	Jacket Hanger
SIZE	380mm
COLOUR	Charcoal Grey
CODE	JUM42CG11
DESCRIPTION	Jacket Hanger
SIZE	420mm
COLOUR	Charcoal Grey
LADIES BOTTOMS	
CODE	BC28A-SPCG11
DESCRIPTION	Adjustable Bottom Hanger w/Soft Pads
SIZE	280mm
COLOUR	Charcoal Grey
CODE	BC33A-SPCG11
DESCRIPTION	Adjustable Bottom Hanger w/Soft Pads
SIZE	330mm
COLOUR	Charcoal Grey

LADIES SLEEPWEAR	
CODE	TC41CG6
DESCRIPTION	Top Hanger
SIZE	410mm
COLOUR	Cool Grey
CODE	TC46CG6
DESCRIPTION	Top Hanger
SIZE	460mm
COLOUR	Cool Grey
CODE	KU41CG6
DESCRIPTION	Knitwear Hanger
SIZE	410mm
COLOUR	Cool Grey
CODE	BC28A-SPCG6
DESCRIPTION	Adjustable Bottom Hanger w/Soft Pads
SIZE	280mm
COLOUR	Cool Grey
CODE	BC33A-SPCG6
DESCRIPTION	Adjustable Bottom Hanger w/Soft Pads
SIZE	330mm
COLOUR	Cool Grey
CODE	AC69CG6
DESCRIPTION	Hook & Loop
SIZE	152mm
COLOUR	Cool Grey
CODE	AC66CG6
DESCRIPTION	Hook & Loop
SIZE	250mm
COLOUR	Cool Grey

# Index - page 3

MENS TOPS	
CODE	TC41CG11
DESCRIPTION	Top Hanger
SIZE	410mm
COLOUR	Charcoal Grey
CODE	TC46CG11
DESCRIPTION	Top Hanger
SIZE	460mm
COLOUR	Charcoal Grey
CODE	TC52CG11
DESCRIPTION	Top Hanger
SIZE	520mm
COLOUR	Charcoal Grey
CODE	KU45CG11
DESCRIPTION	Knitwear Hanger
SIZE	450mm
COLOUR	Charcoal Grey
CODE	JUM46CG11
DESCRIPTION	Jacket Hanger
SIZE	460mm
COLOUR	Charcoal Grey

MENS BOTTOMS	
CODE	BC22A-SPCG11
DESCRIPTION	Adjustable Bottom Hanger w/Soft Pads
SIZE	220mm
COLOUR	Charcoal Grey
CODE	BC28A-SPCG11
DESCRIPTION	Adjustable Bottom Hanger w/Soft Pads
SIZE	280mm
COLOUR	Charcoal Grey
CODE	BC33A-SPCG11
DESCRIPTION	Adjustable Bottom Hanger w/Soft Pads
SIZE	330mm
COLOUR	Charcoal Grey

# Index - page 4

LINGERIE / UNDERWEAR	
CODE	LH35BL
DESCRIPTION	Childrens Briefs
SIZE	205mm
CODE	LH34CR
DESCRIPTION	Ladies Briefs
SIZE	250mm
CODE	LH34BL
DESCRIPTION	Ladies Briefs
SIZE	250mm
CODE	LH76CR
DESCRIPTION	Ladies Briefs
SIZE	310mm
CODE	LH76BL
DESCRIPTION	Ladies Briefs
SIZE	310mm
CODE	UHS26ONL
DESCRIPTION	Free Cut Briefs
SIZE	260mm
CODE	LH75BL & LH75WG2
DESCRIPTION	Childrens Sets
SIZE	210mm
CODE	LH83WG2
DESCRIPTION	Childrens 2 Pce Sets
SIZE	225mm
CODE	LH83BL
DESCRIPTION	Childrens 2 Pce Sets
SIZE	225mm
CODE	LH99CG6
DESCRIPTION	Childrens 3 Pce Sets
SIZE	210mm
CODE	LH99BL
DESCRIPTION	Childrens 3 Pce Sets
SIZE	210mm

LINGERIE / UNDERWEAR cont.	
CODE	LH88BL
DESCRIPTION	Mens 2 Pce Sets
SIZE	260mm
CODE	LH85CR
DESCRIPTION	Mens 2 Pce Sets
SIZE	270mm
CODE	LH85BL
DESCRIPTION	Mens 2 Pce Sets
SIZE	270mm
CODE	LH93CG6
DESCRIPTION	3 Pce Sets
SIZE	260mm
CODE	LH93CR
DESCRIPTION	Ladies 3 Pce Sets
SIZE	260mm
CODE	LH93BL
DESCRIPTION	Ladies 3 Pce Sets
SIZE	260mm
CODE	LH260-3BL
DESCRIPTION	Adults Multi-pack
SIZE	260mm
CODE	BR32CR
DESCRIPTION	Bras
SIZE	285mm
CODE	BR33CR
DESCRIPTION	Bras
SIZE	335mm

# Index - page 5

FOOTWEAR	
CODE	FW24CG11
DESCRIPTION	Thong Hanger
SIZE	115mm
COLOUR	Charcoal Grey
CODE	FW23CG11
DESCRIPTION	U End Hanger
SIZE	70mm
COLOUR	Charcoal Grey
CODE	FW25CG11
DESCRIPTION	Multi Purpose Hanger
SIZE	170mm
COLOUR	Charcoal Grey
CODE	FW77CG11
DESCRIPTION	Multi Purpose Hanger
SIZE	195mm
COLOUR	Charcoal Grey
CODE	FW26CG11
DESCRIPTION	Multi Purpose Hanger
SIZE	215mm
COLOUR	Charcoal Grey
CODE	FW80CG11
DESCRIPTION	Multi Purpose Hanger
SIZE	295mm
COLOUR	Charcoal Grey
CODE	FW79NCG11
DESCRIPTION	Boot Hanger
SIZE	130mm
COLOUR	Charcoal Grey
CODE	FW78CG11
DESCRIPTION	Boot Hanger
SIZE	180mm
COLOUR	Charcoal Grey

ACCESSORIES	
CODE	SC70CG11
DESCRIPTION	Round Scarf Hanger
SIZE	170mm
COLOUR	Charcoal Grey
SIZE	SC29CG11
DESCRIPTION	Shawl Hanger
SIZE	300mm
COLOUR	Charcoal Grey
CODE	AC65CG6
DESCRIPTION	Hook & Loop
SIZE	90 x 70mm
COLOUR	Cool Grey
CODE	AC65CG11
DESCRIPTION	Hook & Loop
SIZE	90 x 70mm
COLOUR	Charcoal Grey
CODE	AC30CG6
DESCRIPTION	Gun Hook
SIZE	70mm
COLOUR	Cool Grey
CODE	AC30CG11
DESCRIPTION	Gun Hook
SIZE	70mm
COLOUR	Charcoal Grey
CODE	AC31CR
DESCRIPTION	Packaging Hook
SIZE	15mm
COLOUR	Clear
CODE	B209CR
DESCRIPTION	Large Packaging Hook
SIZE	55mm
COLOUR	Clear
SIZING	
CODE	ST
DESCRIPTION	Plastic Hook Sizer
CODE	AC16
DESCRIPTION	Plastic Hook Sizer
CODE	CS
DESCRIPTION	Metal Hook Sizer
CODE	NS
DESCRIPTION	Neck Size Clip
CODE	AC21
DESCRIPTION	Footwear Size Tab
CODE	AC22
DESCRIPTION	Lingerie Size Tab

# Children's Top Hangers

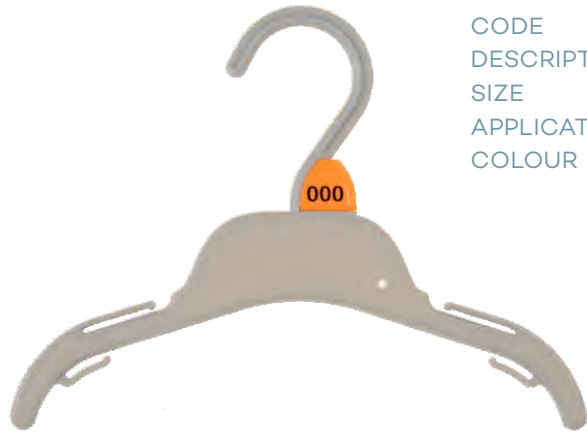

CODE **TC22CG6**  
DESCRIPTION TOP HANGER  
SIZE 220mm  
APPLICATION Rompers, Overalls  
COLOUR Cool Grey

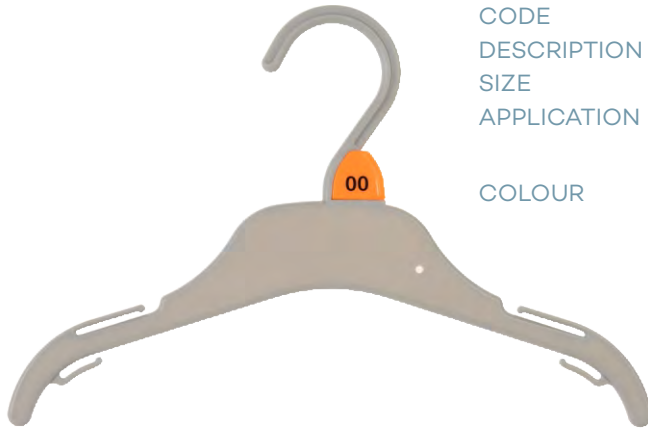

CODE **TC26CG6**  
DESCRIPTION TOP HANGER  
SIZE 260mm  
APPLICATION Tops, Dresses, Knitwear, Jackets,  
Rompers, Overalls, Spencers &  
Sleepwear  
COLOUR Cool Grey

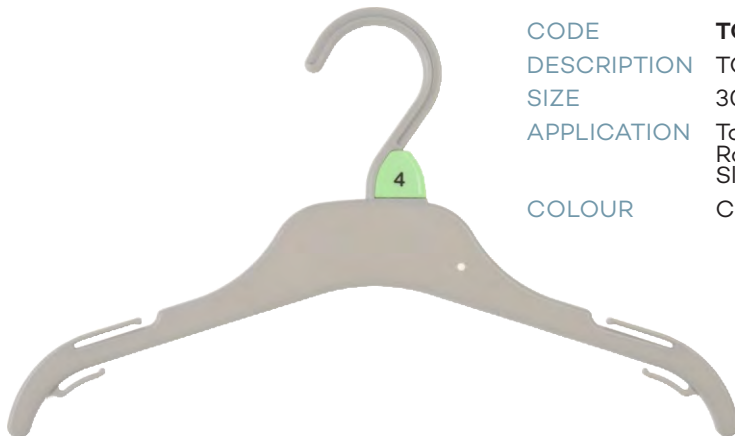

CODE **TC30CG6**  
DESCRIPTION TOP HANGER  
SIZE 300mm  
APPLICATION Tops, Dresses, Knitwear, Jackets,  
Rompers, Overalls, Spencers &  
Sleepwear  
COLOUR Cool Grey



# Children's Top Hangers

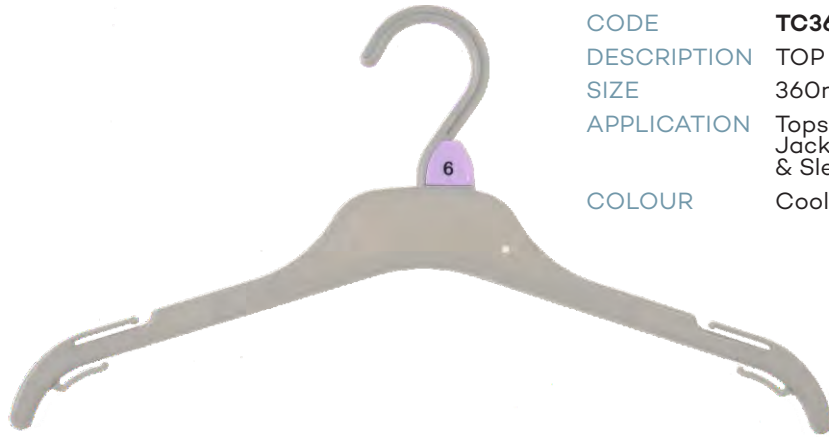

CODE **TC36CG6**  
DESCRIPTION TOP HANGER  
SIZE 360mm  
APPLICATION Tops, Dresses, Knitwear, Jackets, Overalls, Spencers & Sleepwear  
COLOUR Cool Grey



CODE **TC41CG6**  
DESCRIPTION TOP HANGER  
SIZE 410mm  
APPLICATION Tops, Dresses, Knitwear, Jackets, Overalls, Spencers & Sleepwear  
COLOUR Cool Grey



CODE **AC67CBL**  
DESCRIPTION FOAM SLEEVE  
SIZE  
APPLICATION Knitwear

# Children's Bottom Hangers

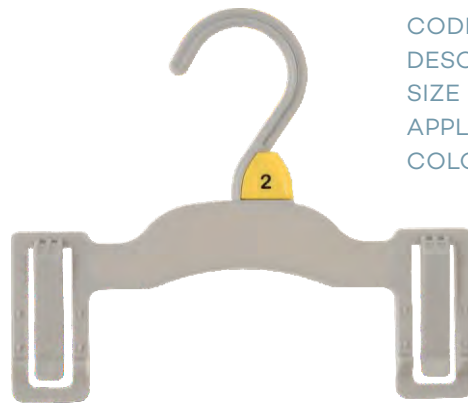

CODE **PC19CG6**  
DESCRIPTION PRONG HANGER  
SIZE 190mm  
APPLICATION Pants, Skirts, Shorts & Sets  
COLOUR Cool Grey

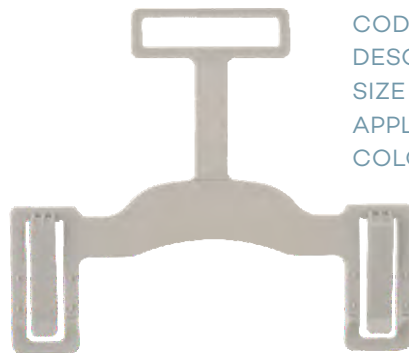

CODE **PC19LCG6**  
DESCRIPTION PRONG HANGER WITH LOOP  
SIZE 190mm  
APPLICATION Pants, Skirts, Shorts & Sets  
COLOUR Cool Grey

# Children's Bottom Hangers



CODE	<b>PC26CG6</b>
DESCRIPTION	PRONG HANGER
SIZE	260mm
APPLICATION	Pants, Skirts, Shorts & Sets
COLOUR	Cool Grey

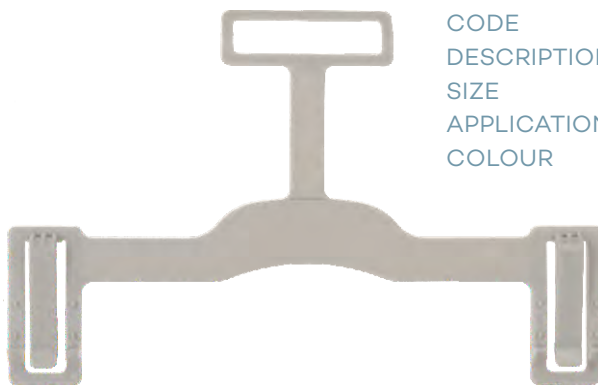

CODE	<b>PC26LCG6</b>
DESCRIPTION	PRONG HANGER WITH LOOP
SIZE	260mm
APPLICATION	Pants, Skirts, Shorts & Sets
COLOUR	Cool Grey

# Children's Bottom Hangers

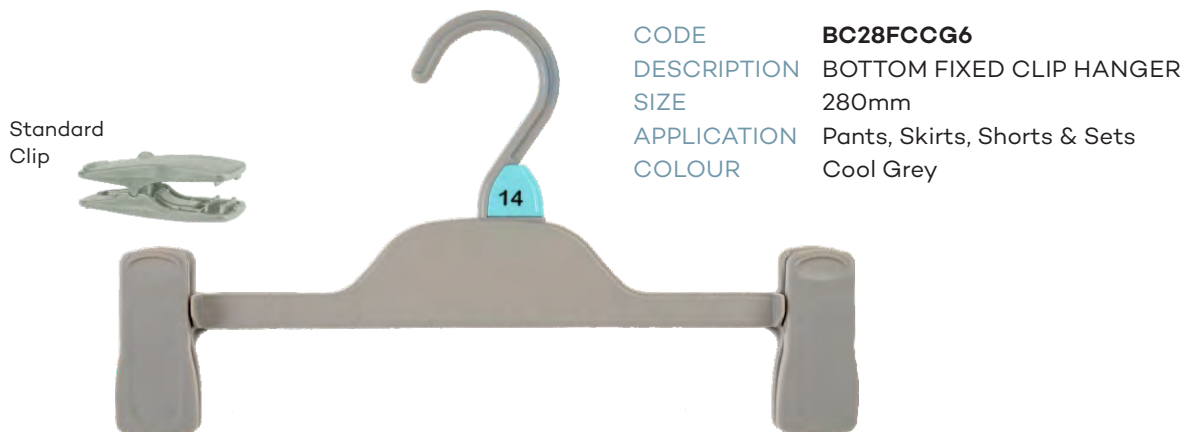

# Children's Multi-Garments

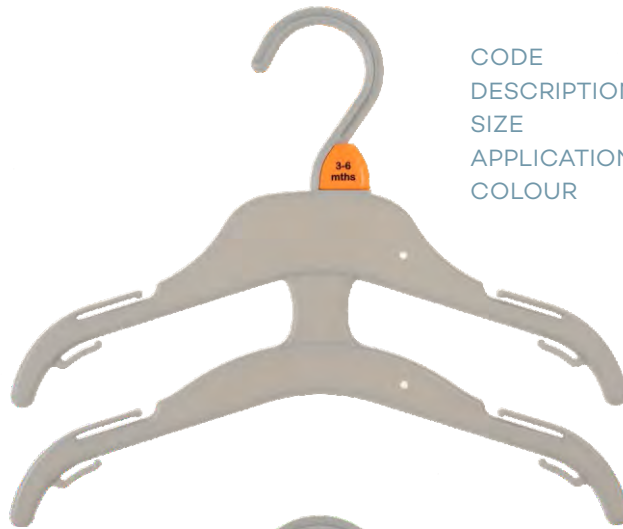

CODE	<b>DTC26CG6</b>
DESCRIPTION	MULTI HANGER
SIZE	260mm
APPLICATION	Multi Garments
COLOUR	Cool Grey

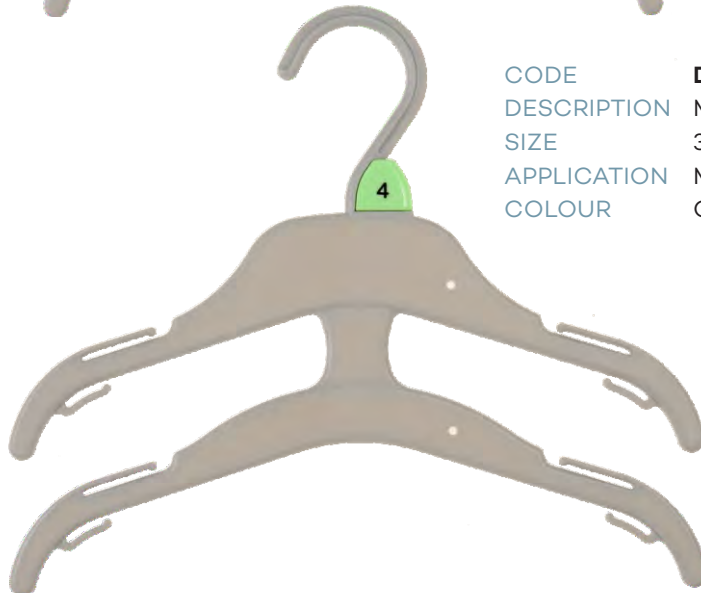

CODE	<b>DTC30CG6</b>
DESCRIPTION	MULTI HANGER
SIZE	300mm
APPLICATION	Multi Garments
COLOUR	Cool Grey

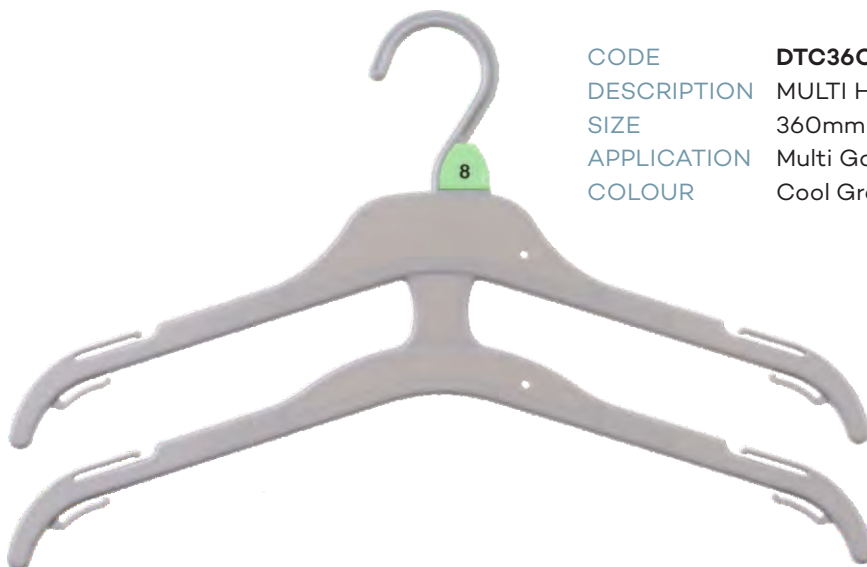

CODE	<b>DTC36CG6</b>
DESCRIPTION	MULTI HANGER
SIZE	360mm
APPLICATION	Multi Garments
COLOUR	Cool Grey

# Children's Multi-Garments

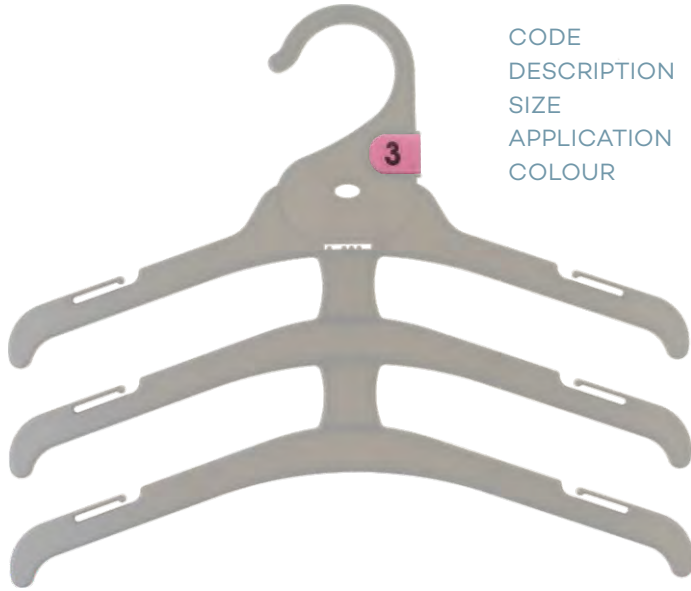

CODE	<b>TH41DS3CG6</b>
DESCRIPTION	TOP TRIPLE HANGER
SIZE	300mm
APPLICATION	Multi Garments
COLOUR	Cool Grey

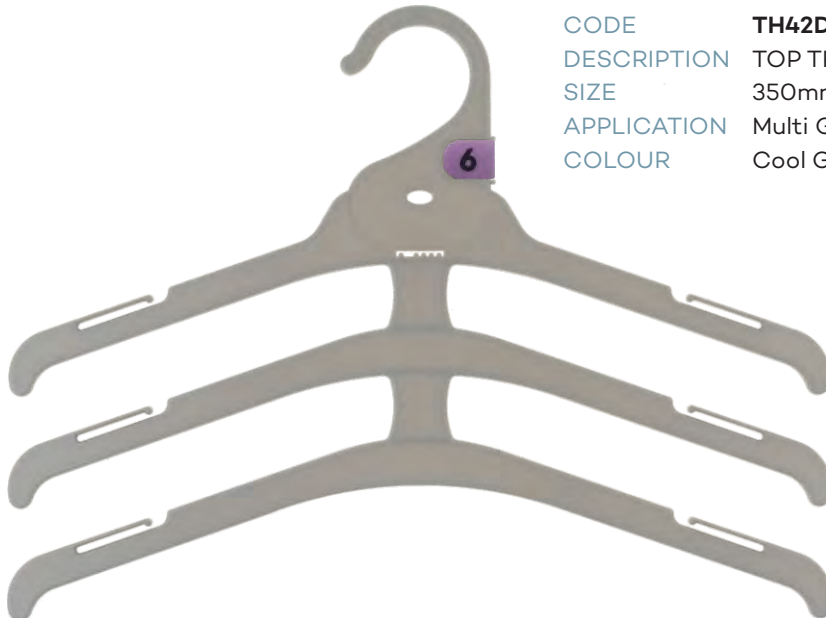

CODE	<b>TH42DS3CG6</b>
DESCRIPTION	TOP TRIPLE HANGER
SIZE	350mm
APPLICATION	Multi Garments
COLOUR	Cool Grey

# Children's Multi-Garments



CODE **TC210-2CG6**  
DESCRIPTION 2-ARM HANGER  
SIZE 210mm  
APPLICATION Sleepsuits, Rompers & Sets  
COLOUR Cool Grey

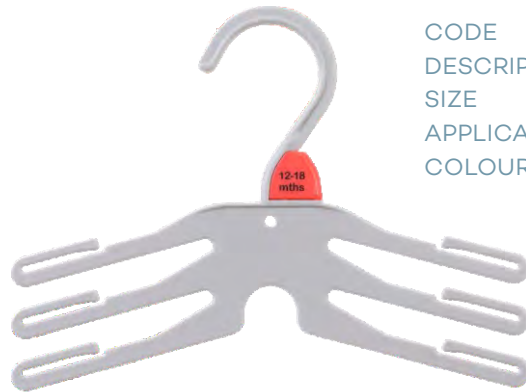

CODE **TC210-3CG6**  
DESCRIPTION 3-ARM HANGER  
SIZE 210mm  
APPLICATION Multi-garments  
COLOUR Cool Grey

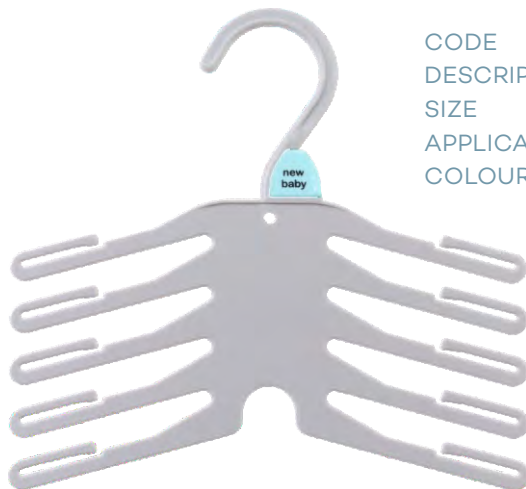

CODE **TC210-5CG6**  
DESCRIPTION 5-ARM HANGER  
SIZE 210mm  
APPLICATION Multi-garments  
COLOUR Cool Grey

# Ladies' Top Hangers



CODE	<b>TC41CG11</b>
DESCRIPTION	TOP HANGER
SIZE	410mm
APPLICATION	Tops, Shirts, Dresses, Lightweight Jackets & Knitwear
COLOUR	Charcoal Grey

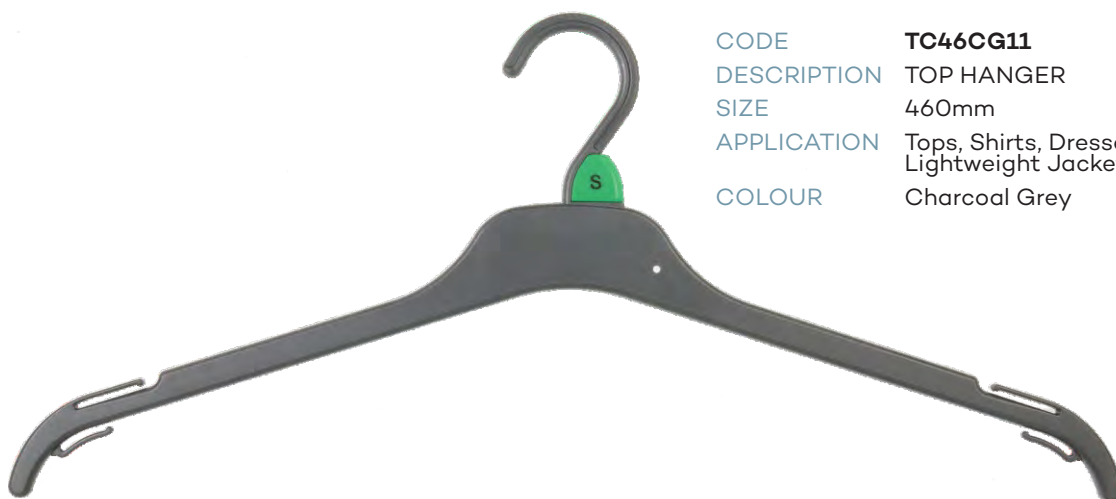

CODE	<b>TC46CG11</b>
DESCRIPTION	TOP HANGER
SIZE	460mm
APPLICATION	Tops, Shirts, Dresses, Lightweight Jackets & Knitwear
COLOUR	Charcoal Grey



# Ladies' Top Hangers

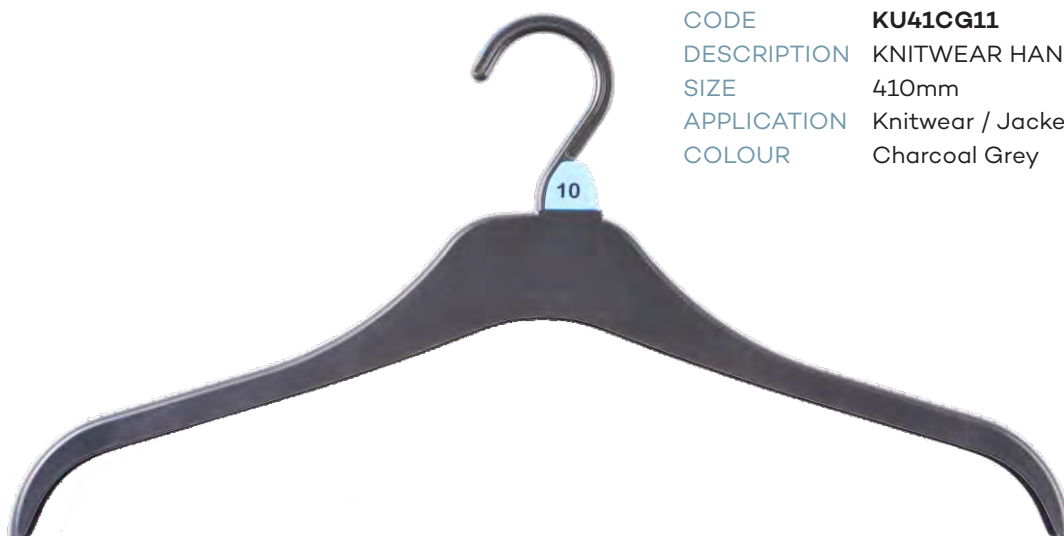

CODE **KU41CG11**  
DESCRIPTION KNITWEAR HANGER  
SIZE 410mm  
APPLICATION Knitwear / Jackets  
COLOUR Charcoal Grey

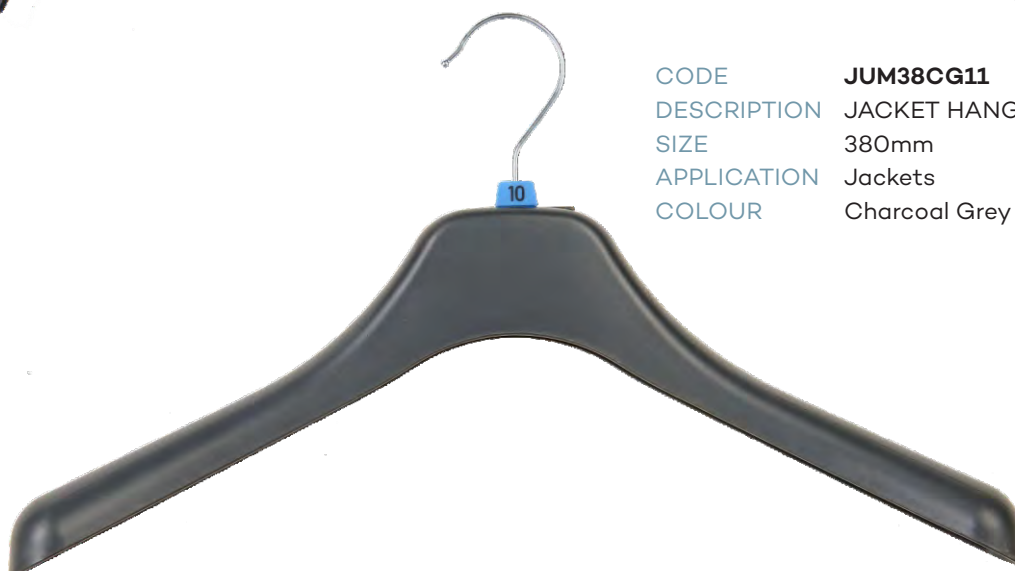

CODE **JUM38CG11**  
DESCRIPTION JACKET HANGER  
SIZE 380mm  
APPLICATION Jackets  
COLOUR Charcoal Grey

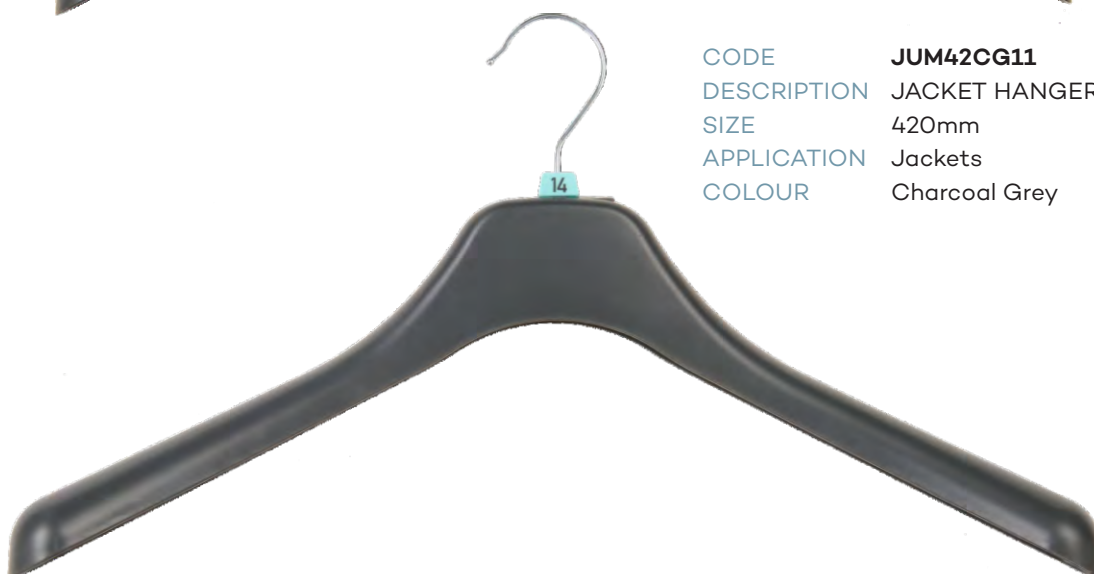

CODE **JUM42CG11**  
DESCRIPTION JACKET HANGER  
SIZE 420mm  
APPLICATION Jackets  
COLOUR Charcoal Grey

# Ladies' Bottom Hangers

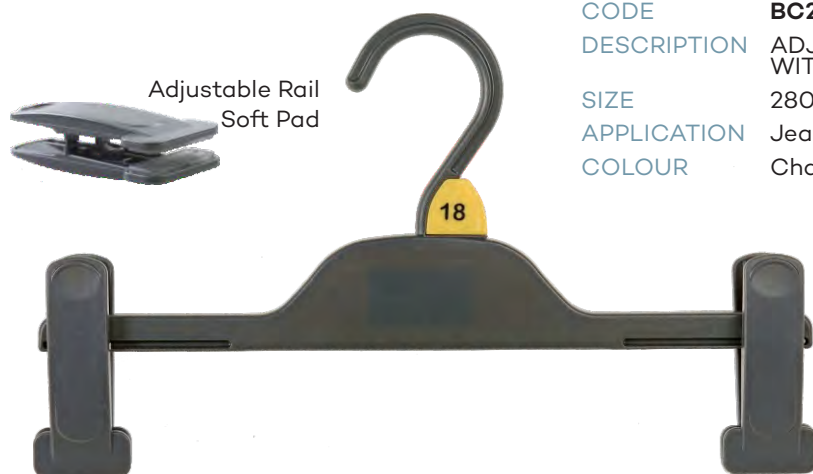

CODE **BC28A-SPCG11**  
DESCRIPTION ADJUSTABLE BOTTOM HANGER WITH SOFT PAD  
SIZE 280mm  
APPLICATION Jeans, Pants, Skirts & Shorts  
COLOUR Charcoal Grey



CODE **BC33A-SPCG11**  
DESCRIPTION ADJUSTABLE BOTTOM HANGER WITH SOFT PAD  
SIZE 330mm  
APPLICATION Jeans, Pants, Skirts & Shorts  
COLOUR Charcoal Grey

# Ladies' Sleepwear

CODE **TC41CG6**  
DESCRIPTION TOP HANGER  
SIZE 410mm  
APPLICATION Sleepwear  
COLOUR Cool Grey



CODE **TC46CG6**  
DESCRIPTION TOP HANGER  
SIZE 460mm  
APPLICATION Sleepwear  
COLOUR Cool Grey

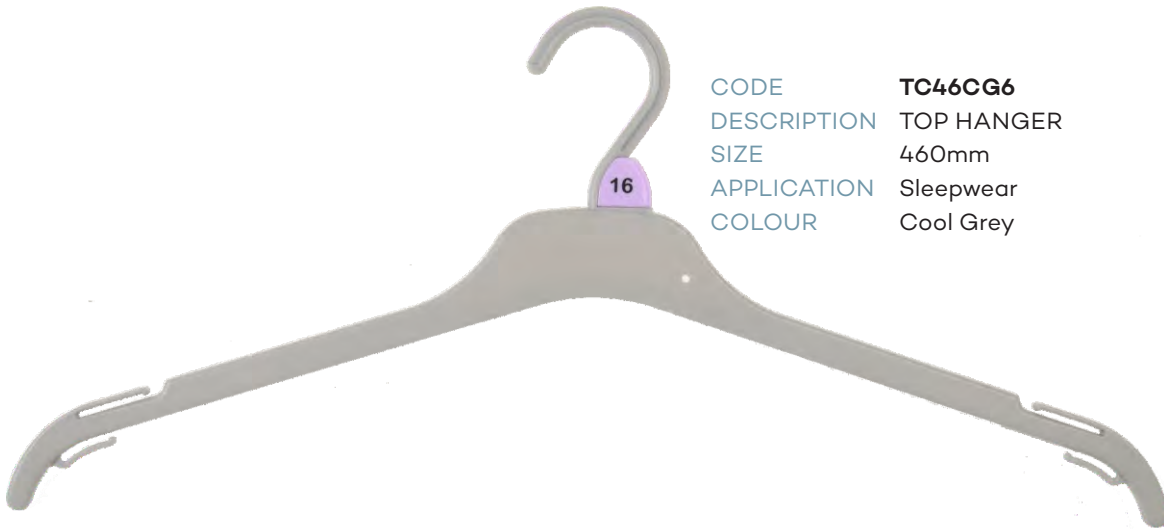

CODE **KU41CG6**  
DESCRIPTION DRESSING GOWN HANGER  
SIZE 410mm  
APPLICATION Sleepwear  
COLOUR Cool Grey

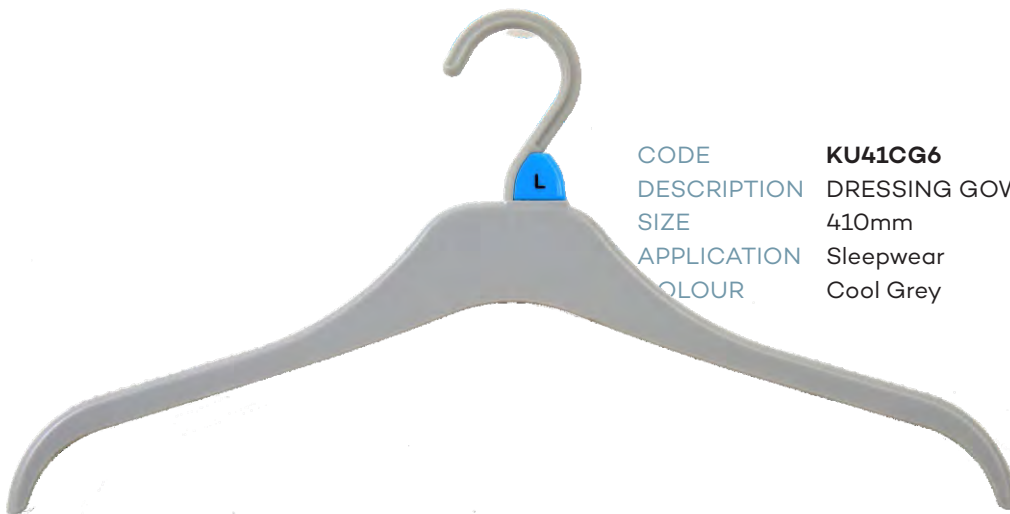

# Ladies' Sleepwear

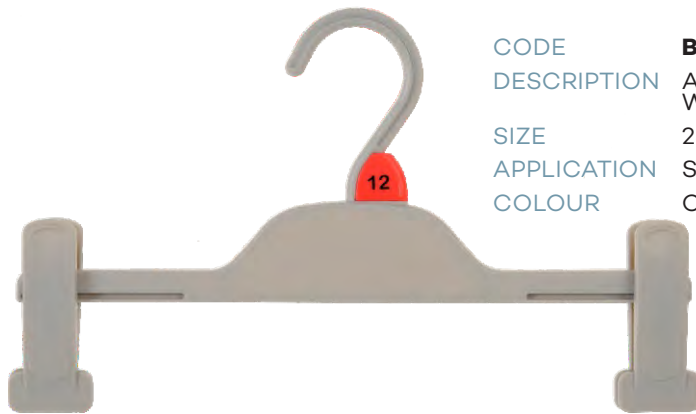

CODE	<b>BC28A-SPCG6</b>
DESCRIPTION	ADJUSTABLE BOTTOM HANGER WITH SOFT PADS
SIZE	280mm
APPLICATION	Sleepwear
COLOUR	Cool Grey

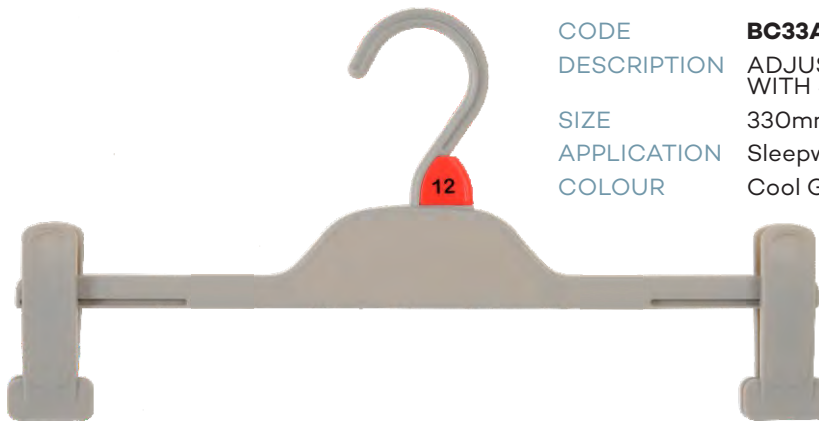

CODE	<b>BC33A-SPCG6</b>
DESCRIPTION	ADJUSTABLE BOTTOM HANGER WITH SOFT PADS
SIZE	330mm
APPLICATION	Sleepwear
COLOUR	Cool Grey

# Ladies' Sleepwear



CODE	<b>AC69CG6</b>
DESCRIPTION	HOOK & LOOP
SIZE	152mm
APPLICATION	Sleepwear
COLOUR	Cool Grey



CODE	<b>AC66CG6</b>
DESCRIPTION	HOOK & LOOP
SIZE	250mm
APPLICATION	Sleepwear
COLOUR	Cool Grey

# Men's Top Hangers



CODE **TC41CG11**  
DESCRIPTION TOP HANGER  
SIZE 410mm  
APPLICATION Tops, Shirts, Lightweight  
Jackets & Knitwear  
COLOUR Charcoal Grey



CODE **TC46CG11**  
DESCRIPTION TOP HANGER  
SIZE 460mm  
APPLICATION Tops, Shirts, Lightweight  
Jackets & Knitwear  
COLOUR Charcoal Grey

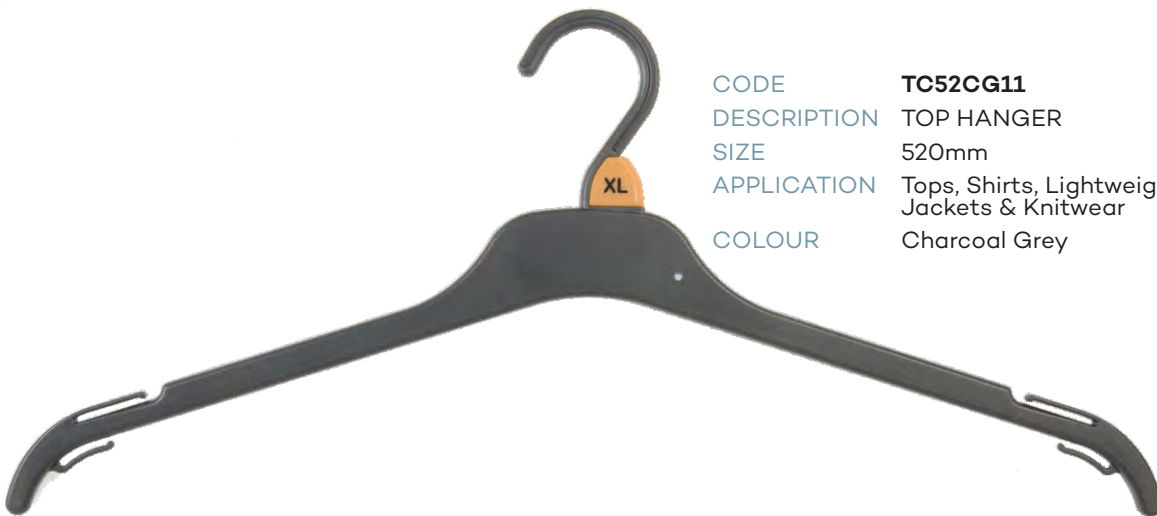

CODE **TC52CG11**  
DESCRIPTION TOP HANGER  
SIZE 520mm  
APPLICATION Tops, Shirts, Lightweight  
Jackets & Knitwear  
COLOUR Charcoal Grey

# Men's Top Hangers

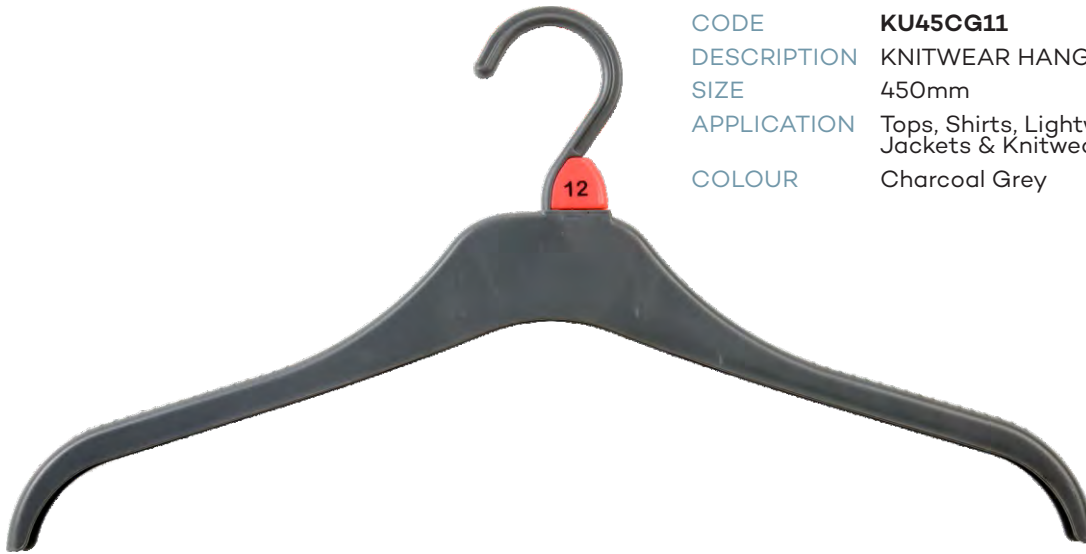

CODE **KU45CG11**  
DESCRIPTION KNITWEAR HANGER  
SIZE 450mm  
APPLICATION Tops, Shirts, Lightweight  
Jackets & Knitwear  
COLOUR Charcoal Grey



CODE **JUM46CG11**  
DESCRIPTION JACKET HANGER  
SIZE 460mm  
APPLICATION Jackets  
COLOUR Charcoal Grey



CODE **AC67BL**  
DESCRIPTION Foam Sleeve

# Men's Bottom Hangers



CODE **BC22A-SPCG11**  
DESCRIPTION ADJUSTABLE BOTTOM HANGER WITH SOFT PAD  
SIZE 220mm  
APPLICATION Jeans, Pants & Shorts  
COLOUR Charcoal Grey



CODE **BC28A-SPCG11**  
DESCRIPTION ADJUSTABLE BOTTOM HANGER WITH SOFT PAD  
SIZE 280mm  
APPLICATION Jeans, Pants & Shorts  
COLOUR Charcoal Grey



CODE **BC33A-SPCG11**  
DESCRIPTION ADJUSTABLE BOTTOM HANGER WITH SOFT PAD  
SIZE 330mm  
APPLICATION Jeans, Pants & Shorts  
COLOUR Charcoal Grey



# Underwear / Lingerie



CODE **LH35BL**  
DESCRIPTION CHILDRENS BRIEFS  
SIZE 205mm  
APPLICATION Briefs, Swimwear & Leggins  
COLOUR Black



CODE **LH34CR**  
DESCRIPTION LADIES BRIEFS  
SIZE 250mm  
APPLICATION Briefs, Swimwear & Activewear  
COLOUR Crystal

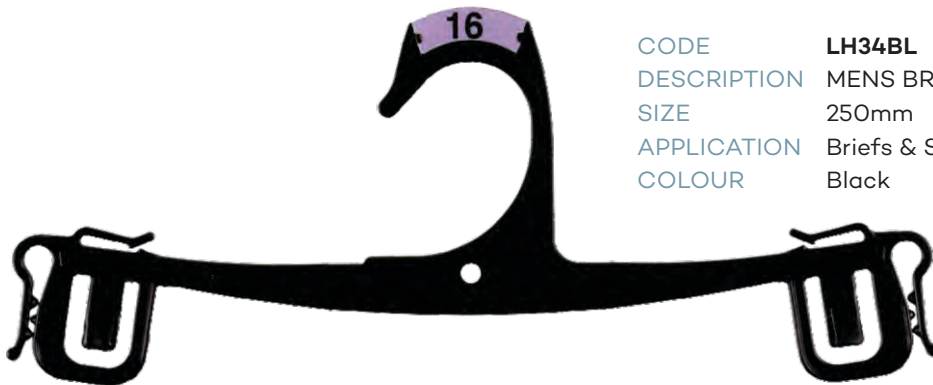

CODE **LH34BL**  
DESCRIPTION MENS BRIEFS  
SIZE 250mm  
APPLICATION Briefs & Swimwear  
COLOUR Black

# Underwear / Lingerie



CODE **LH76CR**  
DESCRIPTION LADIES BRIEFS  
SIZE 310mm  
APPLICATION Briefs & Activewear  
COLOUR Crystal

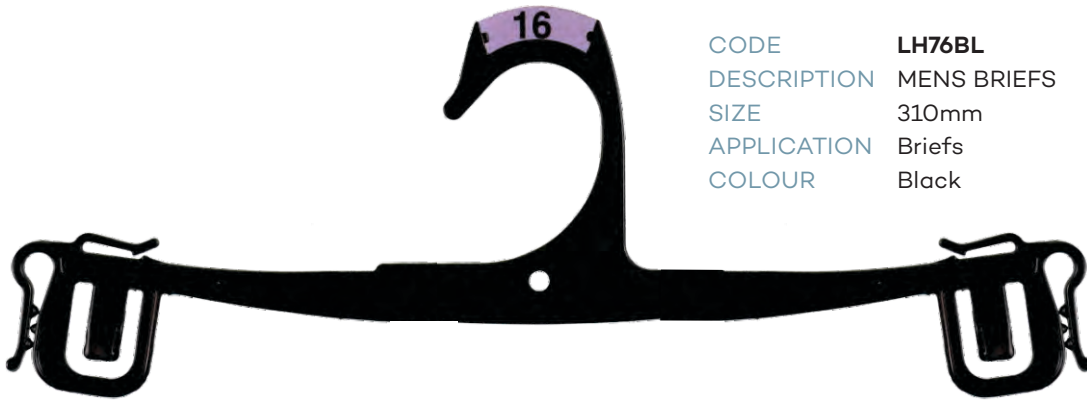

CODE **LH76BL**  
DESCRIPTION MENS BRIEFS  
SIZE 310mm  
APPLICATION Briefs  
COLOUR Black

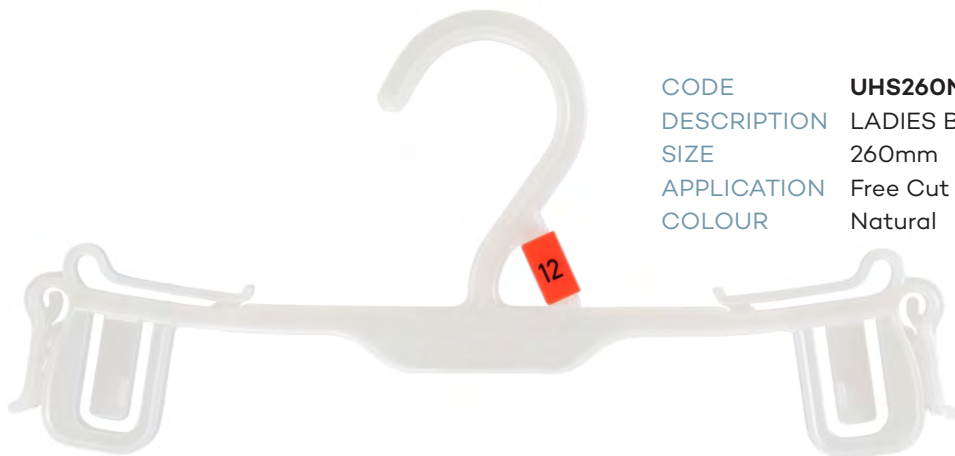

CODE **UHS260NL**  
DESCRIPTION LADIES BRIEFS  
SIZE 260mm  
APPLICATION Free Cut Brief  
COLOUR Natural

# Underwear / Lingerie

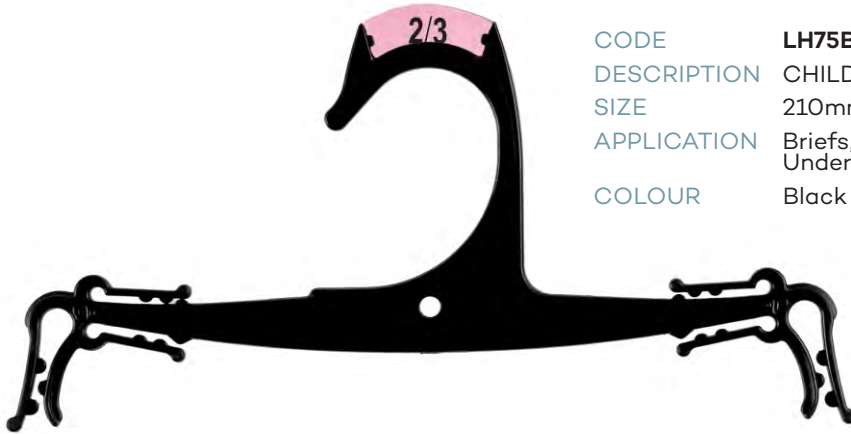

CODE **LH75BL / LH75WG2**  
DESCRIPTION CHILDRENS SETS  
SIZE 210mm  
APPLICATION Briefs, Camisoles & Underwear Sets  
COLOUR Black & Warm Grey 2

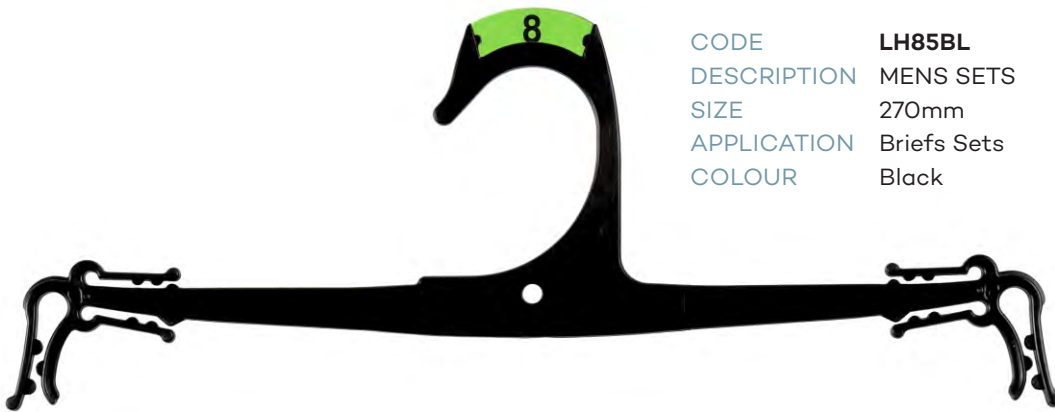

CODE **LH85BL**  
DESCRIPTION MENS SETS  
SIZE 270mm  
APPLICATION Briefs Sets  
COLOUR Black

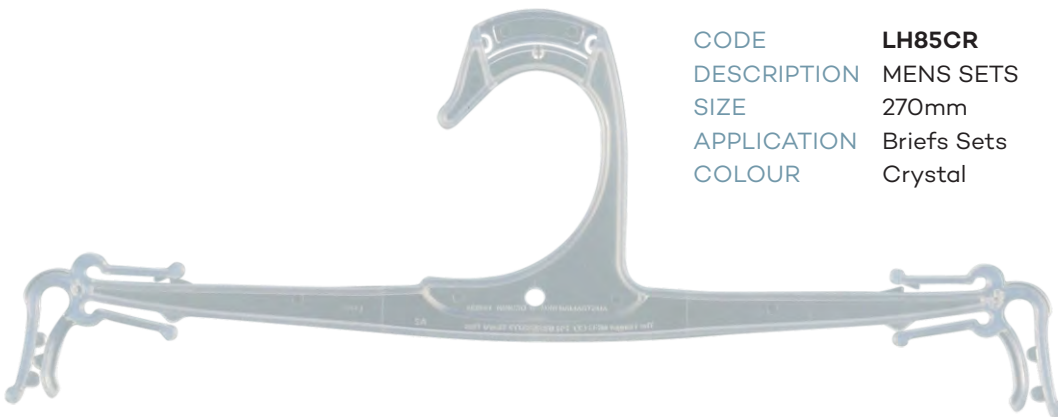

CODE **LH85CR**  
DESCRIPTION MENS SETS  
SIZE 270mm  
APPLICATION Briefs Sets  
COLOUR Crystal

# Underwear / Lingerie

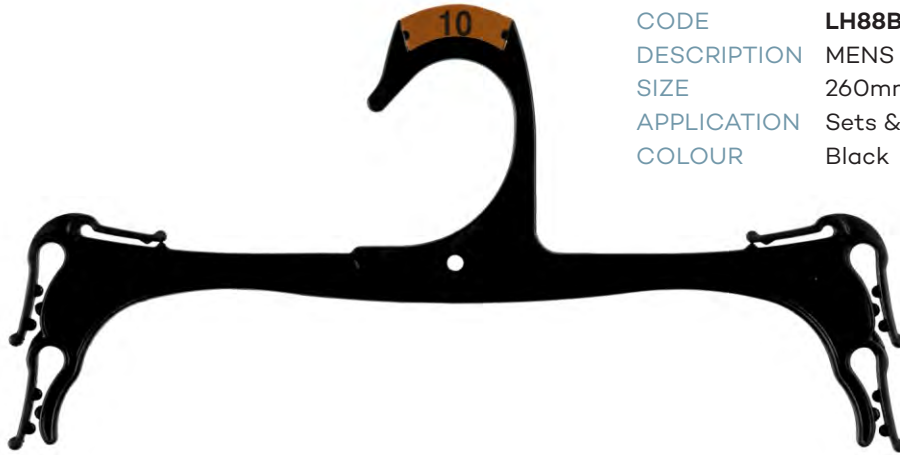

CODE **LH88BL**  
DESCRIPTION MENS 2 PCE  
SIZE 260mm  
APPLICATION Sets & Multi-Garments  
COLOUR Black

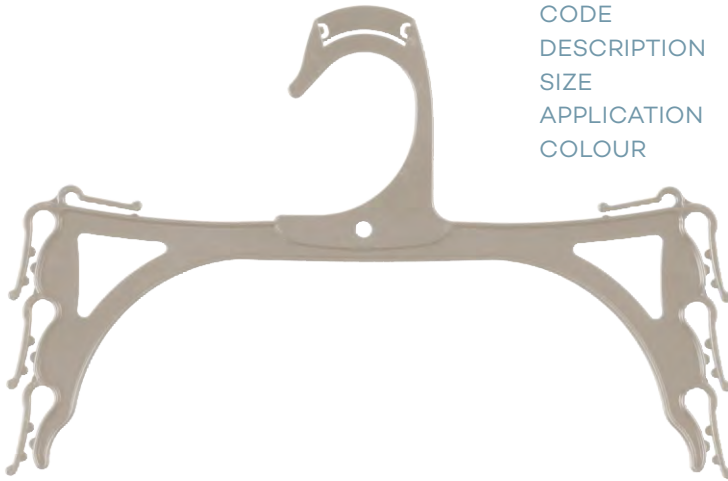

CODE **LH99CG6**  
DESCRIPTION CHILDRENS 3 PCE SET  
SIZE 210mm  
APPLICATION Sets & Multi-Garments  
COLOUR Cool Grey



CODE **LH99BL**  
DESCRIPTION CHILDRENS 3 PCE SET  
SIZE 210mm  
APPLICATION Sets & Multi-Garments  
COLOUR Black

# Underwear / Lingerie



CODE **LH93CG6**  
DESCRIPTION LADIES 3 PCE  
SIZE 260mm  
APPLICATION Sets & Multi-Garments  
COLOUR Cool Grey

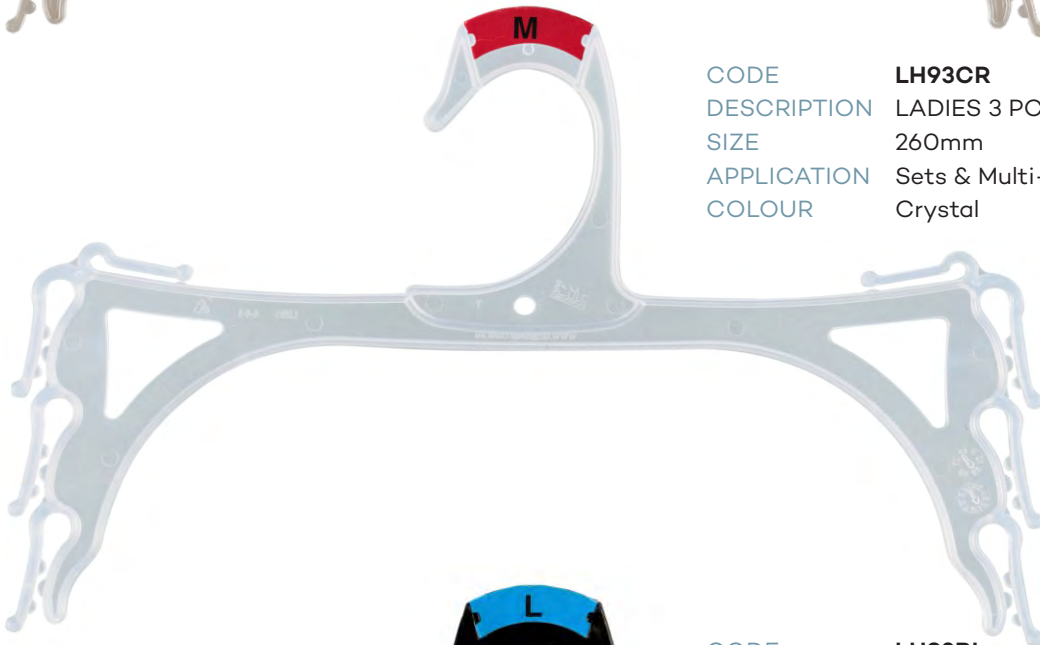

CODE **LH93CR**  
DESCRIPTION LADIES 3 PCE  
SIZE 260mm  
APPLICATION Sets & Multi-Garments  
COLOUR Crystal

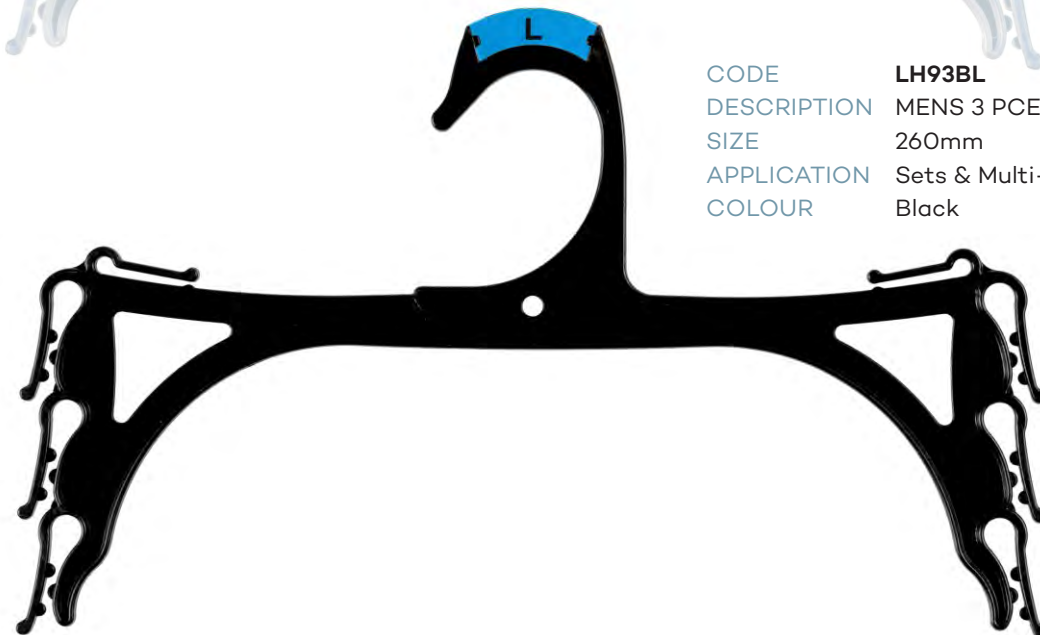

CODE **LH93BL**  
DESCRIPTION MENS 3 PCE  
SIZE 260mm  
APPLICATION Sets & Multi-Garments  
COLOUR Black

# Underwear / Lingerie



CODE	<b>LH260-3BL</b>
DESCRIPTION	ADULTS 3 PCE
SIZE	260mm
APPLICATION	Multi Packs
COLOUR	Black

# Underwear / Lingerie



CODE **LH83WG2**  
DESCRIPTION CHILDRENS 2 PCE  
SIZE 210mm  
APPLICATION Sets & Multi-Garments  
COLOUR Warm Grey 2



CODE **LH83BL**  
DESCRIPTION CHILDRENS 2 PCE  
SIZE 210mm  
APPLICATION Sets & Multi-Garments  
COLOUR Black



CODE **BR32CR**  
DESCRIPTION BRAS  
SIZE 285mm  
APPLICATION Bras  
COLOUR Crystal



CODE **BR33CR**  
DESCRIPTION BRAS  
SIZE 335mm  
APPLICATION Bras  
COLOUR Crystal

# Footwear



CODE **FW24CG11**  
DESCRIPTION THONG HANGER  
SIZE 115mm  
APPLICATION Footwear - Thongs  
COLOUR Charcoal Grey



CODE **FW23CG11**  
DESCRIPTION U END HANGER  
SIZE 70mm  
APPLICATION Casual, Canvas & Court Shoes  
COLOUR Charcoal Grey



# Footwear



CODE **FW25CG11**  
DESCRIPTION MULTI-PURPOSE HANGER  
SIZE 170mm  
APPLICATION Shoes, Slippers & Scuffs  
COLOUR Charcoal Grey



CODE **FW77CG11**  
DESCRIPTION MULTI-PURPOSE HANGER  
SIZE 195mm  
APPLICATION Shoes, Slippers & Scuffs  
COLOUR Charcoal Grey



CODE **FW26CG11**  
DESCRIPTION MULTI-PURPOSE HANGER  
SIZE 215mm  
APPLICATION Shoes, Slippers & Scuffs  
COLOUR Charcoal Grey

# Footwear



CODE	<b>FW80CG11</b>
DESCRIPTION	MULTI-PURPOSE HANGER
SIZE	295mm
APPLICATION	Larger Shoes
COLOUR	Charcoal Grey

# Footwear



CODE **FW79NCG11**  
DESCRIPTION BOOT HANGER  
SIZE 130mm  
APPLICATION Boots  
COLOUR Charcoal Grey



CODE **FW78CG11**  
DESCRIPTION BOOT HANGER  
SIZE 180mm  
APPLICATION Boots  
COLOUR Charcoal Grey

# Accessories



CODE	<b>SC70CG11</b>
DESCRIPTION	ROUND SCARF HANGER
SIZE	170mm
APPLICATION	Scarves
COLOUR	Charcoal Grey



CODE	<b>SC29CG11</b>
DESCRIPTION	SHAWL HANGER
SIZE	300mm
APPLICATION	Scarf
COLOUR	Charcoal Grey

# Accessories

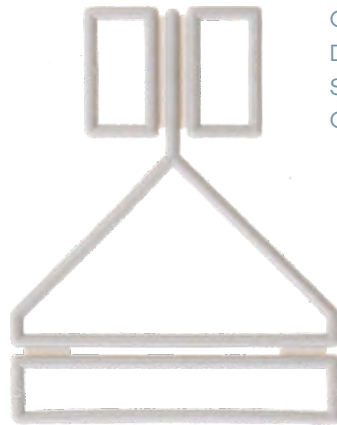

CODE **AC65CG6**  
DESCRIPTION HOOK & LOOP  
SIZE 90 x 70mm  
COLOUR Cool Grey

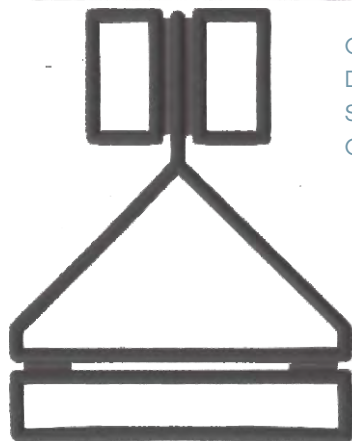

CODE **AC65CG11**  
DESCRIPTION HOOK & LOOP  
SIZE 90 x 70mm  
COLOUR Charcoal Grey



CODE **AC31CR**  
DESCRIPTION PACKAGING HOOK  
SIZE 15mm  
APPLICATION Packaged Products  
COLOUR Clear



CODE **B209CR**  
DESCRIPTION LARGE PACKAGING HOOK  
SIZE 55mm  
APPLICATION Packaged Products  
COLOUR Clear



CODE **AC30CG6**  
DESCRIPTION GUN HOOK  
SIZE 70mm  
APPLICATION Hats & Gloves  
COLOUR Cool Grey



CODE **AC30CG11**  
DESCRIPTION GUN HOOK  
SIZE 70mm  
APPLICATION Hats & Gloves  
COLOUR Charcoal Grey

# Size Tabs



CODE **ST**  
DESCRIPTION Plastic Hook



CODE **AC16**  
DESCRIPTION Plastic Hook



CODE **CS**  
DESCRIPTION Metal Hook



CODE **NS**  
DESCRIPTION Neck Size Clip



CODE **AC22**  
DESCRIPTION Lingerie / Underwear



CODE **AC21**  
DESCRIPTION Footwear

# Printed - Preview



CODE	<b>TC41PWHSI</b>
DESCRIPTION	PREVIEW TOP HANGER
SIZE	410mm
APPLICATION	Ladies
COLOUR	Silver



CODE	<b>TC46PWHSI</b>
DESCRIPTION	PREVIEW TOP HANGER
SIZE	460mm
APPLICATION	Mens
COLOUR	Silver



CODE	<b>KU45PWHSI</b>
DESCRIPTION	PREVIEW KNITWEAR HANGER
SIZE	450mm
APPLICATION	Mens
COLOUR	Silver

# Printed - Preview



CODE	<b>JUM38PWH SI</b>
DESCRIPTION	PREVIEW JACKET HANGER
SIZE	380mm
APPLICATION	Ladies
COLOUR	Silver



CODE	<b>JUM42PWH SI</b>
DESCRIPTION	PREVIEW JACKET HANGER
SIZE	420mm
APPLICATION	Ladies
COLOUR	Silver

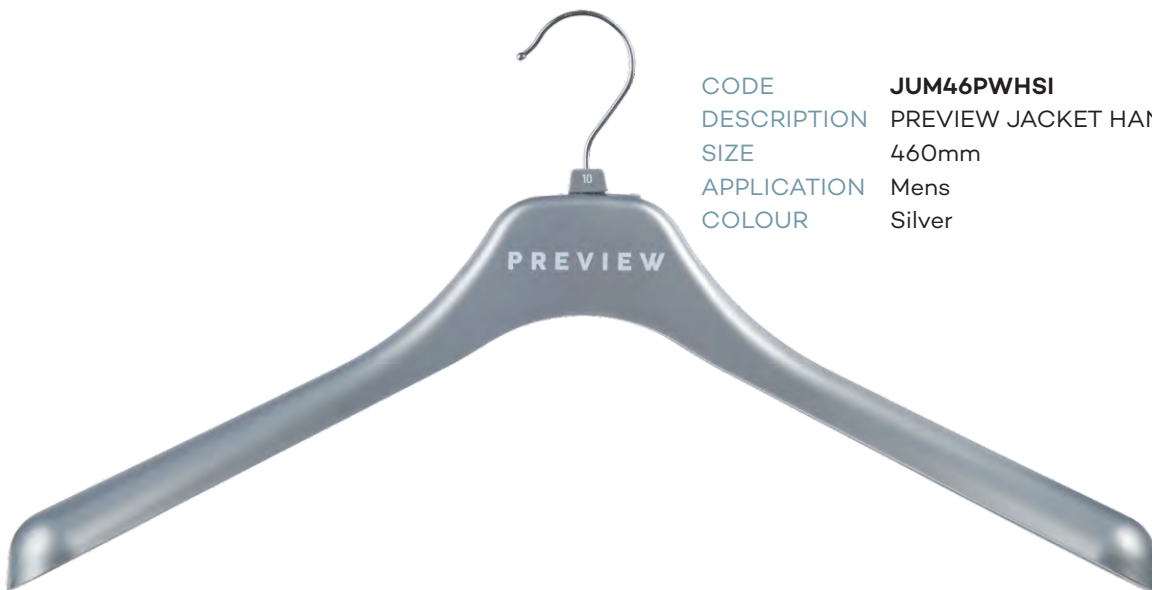

CODE	<b>JUM46PWH SI</b>
DESCRIPTION	PREVIEW JACKET HANGER
SIZE	460mm
APPLICATION	Mens
COLOUR	Silver



# Printed - Preview



CODE	<b>BC22A-SPPWHSI</b>
DESCRIPTION	PREVIEW PRINT BOTTOM HANGER
SIZE	220mm
APPLICATION	Mens
COLOUR	Silver



CODE	<b>BC28A-SPPWHSI</b>
DESCRIPTION	PREVIEW PRINT BOTTOM HANGER
SIZE	280mm
APPLICATION	Mens
COLOUR	Silver



CODE	<b>BC33A-SPPWHSI</b>
DESCRIPTION	PREVIEW PRINT BOTTOM HANGER
SIZE	330mm
APPLICATION	Ladies & Mens
COLOUR	Silver

# Printed - Dannii Minogue Petites



CODE **TC36DMPWHRDBL**  
DESCRIPTION DANNII TOP HANGER  
SIZE 360mm  
APPLICATION Adults  
COLOUR Black



CODE **TC41DMPWHRDBL**  
DESCRIPTION DANNII TOP HANGER  
SIZE 410mm  
APPLICATION Adults  
COLOUR Black



CODE **BC33A-SPDMPWHRDBL**  
DESCRIPTION DANNII BOTTOM HANGER  
SIZE 330mm  
APPLICATION Adults  
COLOUR Black

# Printed - Dannii Minogue Petites

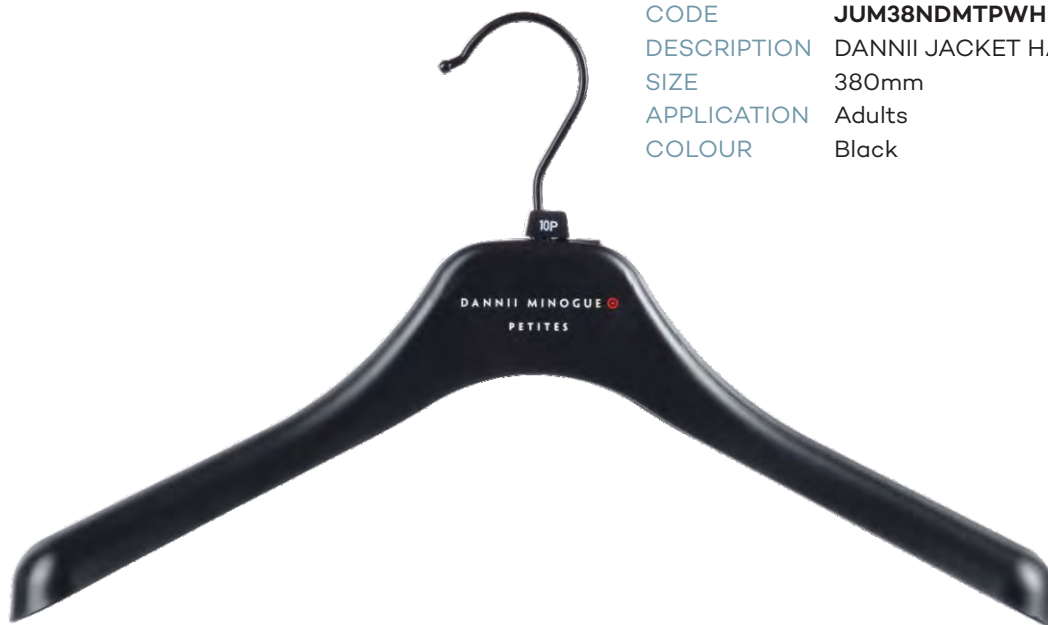

CODE	<b>JUM38NDMTPWHRDBL</b>
DESCRIPTION	DANNII JACKET HANGER
SIZE	380mm
APPLICATION	Adults
COLOUR	Black



CODE	<b>JUM42NDMTPWHRDBL</b>
DESCRIPTION	DANNII JACKET HANGER
SIZE	420mm
APPLICATION	Adults
COLOUR	Black

# Printed - Piping Hot



CODE **TC30PHBLWH**  
DESCRIPTION PIPING HOT TOP HANGER  
SIZE 300mm  
APPLICATION Childrens  
COLOUR White



CODE **TC36PHBLWH**  
DESCRIPTION PIPING HOT TOP HANGER  
SIZE 360mm  
APPLICATION Childrens  
COLOUR White



CODE **TC41PHBLWH**  
DESCRIPTION PIPING HOT TOP HANGER  
SIZE 410mm  
APPLICATION Adults  
COLOUR White



CODE **TC46PHBLWH**  
DESCRIPTION PIPING HOT TOP HANGER  
SIZE 460mm  
APPLICATION Adults  
COLOUR White

# Printed - Piping Hot



CODE	<b>BC28A-SPPHBLWH</b>
DESCRIPTION	PIPING HOT BOTTOM MOVABLE CLIP HANGER
SIZE	280mm
APPLICATION	Adults
COLOUR	White



CODE	<b>BC33A-SPPHBLWH</b>
DESCRIPTION	PIPING HOT BOTTOM MOVABLE CLIP HANGER
SIZE	330mm
APPLICATION	Adults
COLOUR	White

# Printed - Piping Hot

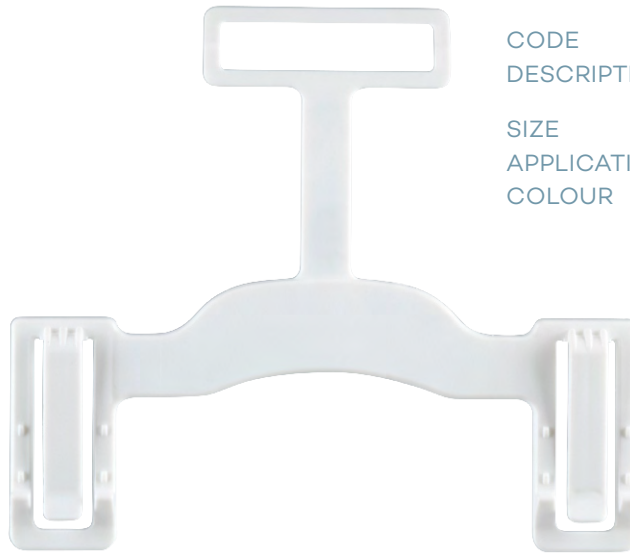

CODE	<b>PC19LWH</b>
DESCRIPTION	PIPING HOT BOTTOM HANGER WITH LOOP
SIZE	190mm
APPLICATION	Childrens
COLOUR	White

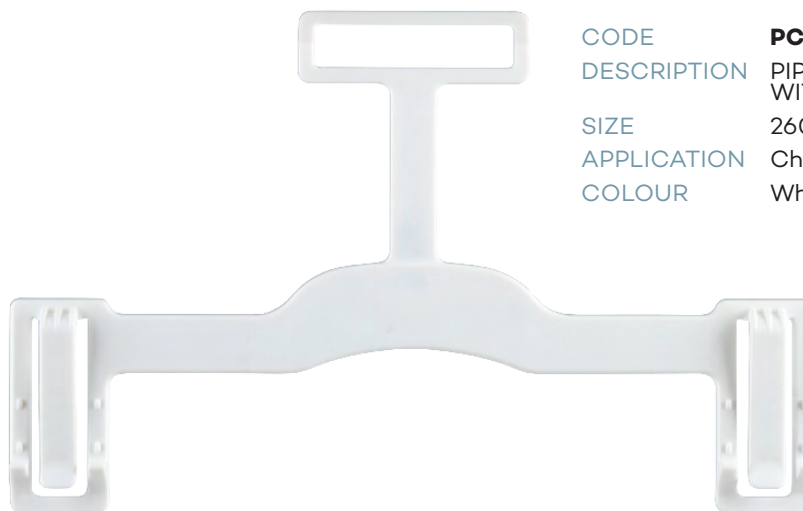

CODE	<b>PC26LWH</b>
DESCRIPTION	PIPING HOT BOTTOM HANGER WITH LOOP
SIZE	260mm
APPLICATION	Childrens
COLOUR	White

# Printed - Piping Hot



CODE **BC22FCPHBLWH**  
DESCRIPTION PIPING HOT BOTTOM  
FIXED CLIP HANGER

SIZE 220mm  
APPLICATION Childrens  
COLOUR White



CODE **BC25FCPHBLWH**  
DESCRIPTION PIPING HOT BOTTOM  
FIXED CLIP HANGER

SIZE 250mm  
APPLICATION Childrens  
COLOUR White



CODE **BC28FCPHBLWH**  
DESCRIPTION PIPING HOT BOTTOM  
FIXED CLIP HANGER

SIZE 280mm  
APPLICATION Childrens  
COLOUR White

# Printed - Piping Hot



CODE **LH75WH**  
DESCRIPTION PIPING HOT UNDERWEAR SET HANGER  
SIZE 210mm  
APPLICATION Childrens  
COLOUR White



CODE **LH85WH**  
DESCRIPTION PIPING HOT UNDERWEAR SET HANGER  
SIZE 270mm  
APPLICATION Childrens  
COLOUR White



CODE **LH34WH**  
DESCRIPTION PIPING HOT BRIEF HANGER  
SIZE 250mm  
APPLICATION Adults  
COLOUR White



CODE **LH76WH**  
DESCRIPTION PIPING HOT BRIEF HANGER  
SIZE 310mm  
APPLICATION Adults  
COLOUR White



CODE **AC82PHBLWH**  
DESCRIPTION PIPING HOT BRAND PLATE  
APPLICATION Underwear Hangers  
COLOUR White



# "ST" Size Clips Outerwear

CHILDRENSWEAR		
SIZE	PMS	COLOUR
tiny baby	396	Lime
new baby	318	Turquoise
nb-3mths	347	Dark Green
0-3mths	347	Dark Green
0-6mths	164	Orange
3-6mths	164	Orange
3-12mths	264	Pink
6-12mths	264	Lilac
6-18mths	185	Red
12-18mths	185	Red
12-24mths	121	Yellow
18-24mths	121	Yellow
000000	BLK	Black
00000	396	Lime
0000	318	Turquoise
000	347	Dark Green
00	164	Orange
0	264	Lilac
1	185	Red
2	121	Yellow
3	230	Pink
4	359	Pale Green
5	154	Tan Brown
6	264	Lilac
7	444	Grey
8	185	Red
9	230	Pink
10	279	Dark Blue
11	347	Dark Green
12	347	Dark Green
14	318	Turquoise
16	154	Tan Brown
1-3	230	Pink
2/3	230	Pink
3/4	359	Pale Green
4/6	264	Lilac
5/6	264	Lilac
5/7	444	Grey
6/8	185	Red
7/8	185	Red
8/10	279	Dark Blue
10/12	347	Dark Green
12/14	318	Turquoise
14/16	154	Tan Brown
XS	318	Turquoise
S	347	Dark Green
M	185	Red
L	PB	Proc Blue
XL	157	Brown

LADIESWEAR		
SIZE	PMS	COLOUR
4	318	Turquoise
6	506	Maroon
8	359	Pale Green
9	MAG	Magenta
10	154	Tan Brown
11	359	Pale Green
12	185	Red
13	155	Buff Yellow
14	279	Dark Blue
16	264	Lilac
18	121	Yellow
20	347	Dark Green
22	444	Grey
24	164	Orange
26	230	Pink
28	264	Lilac
16+	264	Lilac
18+	121	Yellow
20+	347	Dark Green
22+	444	Grey
24+	164	Orange
26+	230	Pink
6/8	359	Pale Green
8/10	154	Tan Brown
10/12	185	Red
10/16	264	Lilac
12/14	279	Dark Blue
14/16	264	Lilac
16/18	121	Yellow
18/20	347	Dark Green
18/22	444	Grey
20/22	444	Grey
22/24	164	Orange
24/26	230	Pink
26/28	264	Lilac
XXS	264	Lilac
XXS/XS	318	Turquoise
XS	318	Turquoise
S	347	Dark Green
S+	347	Dark Green
S/M	185	Red
M	185	Red
M+	185	Red
M/L	PB	Proc Blue
L	PB	Proc Blue
L+	PB	Proc Blue
L/XL	157	Brown
XL	157	Brown
XL+	157	Brown
XXL	375	Bright Green
XXL/XXXL	121	Yellow
OSFM	WHT	White

MENSWEAR		
SIZE	PMS	COLOUR
26	154	Tan Brown
28	264	Lilac
30	BLK	Black
32	347	Dark Green
34	185	Red
36	PB	Proc Blue
38	157	Brown
39	347	Dark Green
40	375	Bright Green
41	PB	Proc Blue
42	121	Yellow
43	375	Bright Green
44	154	Tan Brown
46	150	Light Orange
48	BLK	Black
50	444	Grey
52	MAG	Magenta
30/77	318	Turquoise
32/82	347	Dark Green
34/87	185	Red
36/92	PB	Proc Blue
38/97	157	Brown
40/102	375	Bright Green
42/107	121	Yellow
107	121	Yellow
112	154	Tan Brown
117	150	Light Orange
122	BLK	Black
127	444	Grey
132	MAG	Magenta
XS	318	Turquoise
S	347	Dark Green
S/M	185	Red
M	185	Red
L	PB	Proc Blue
L/XL	157	Brown
XL	157	Brown
XXL	375	Bright Green
XXXL	121	Yellow
2XL	375	Bright Green
3XL	121	Yellow
4XL	154	Tan Brown
5XL	150	Light Orange
6XL	BLK	Black
7XL	444	Grey
8XL	MAG	Magenta
XS/S	347	Dark Green
M/L	PB	Proc Blue
XL/XXL	375	Bright Green
3XL/4XL	154	Tan Brown
5XL/6XL	WHT	White
7XL/8XL	MAG	Magenta
OSFM	WHT	White

# "AC22" Sizes Lingerie / Underwear

LADIESWEAR		
SIZE	PMS	COLOUR
8	359	Pale Green
10	154	Tan Brown
12	185	Red
14	279	Dark Blue
16	264	Lilac
18	121	Yellow
20	347	Dark Green
22	444	Grey
24	164	Orange
26	230	Pink
6/8	359	Pale Green
8/10	154	Tan Brown
10/12	185	Red
12/14	279	Dark Blue
14/16	264	Lilac
16/18	121	Yellow
18/20	347	Dark Green
20/22	444	Grey
22/24	164	Orange
24/26	230	Pink
8A	359	Pale Green
8AA	359	Pale Green
8B	359	Pale Green
8C	359	Pale Green
10AA	154	Tan Brown
10A	154	Tan Brown
10B	154	Tan Brown
10C	154	Tan Brown
10D	154	Tan Brown
10DD	154	Tan Brown
10E	154	Tan Brown
12AA	185	Red
12A	185	Red
12B	185	Red
12C	185	Red
12D	185	Red
12DD	185	Red
12E	185	Red
12F	185	Red
12G	185	Red
14A	279	Dark Blue
14AA	279	Dark Blue
14B	279	Dark Blue
14C	279	Dark Blue
14D	279	Dark Blue
14DD	279	Dark Blue
14E	279	Dark Blue
14F	279	Dark Blue
14G	279	Dark Blue

LADIESWEAR		
SIZE	PMS	COLOUR
16A	264	Lilac
16B	264	Lilac
16C	264	Lilac
16D	264	Lilac
16DD	264	Lilac
16E	264	Lilac
16F	264	Lilac
16G	264	Lilac
18B	121	Yellow
18C	121	Yellow
18D	121	Yellow
18DD	121	Yellow
18E	121	Yellow
18F	121	Yellow
18G	121	Yellow
20B	347	Dark Green
20C	347	Dark Green
20D	347	Dark Green
20DD	347	Dark Green
20E	347	Dark Green
20F	347	Dark Green
20G	347	Dark Green
22B	444	Grey
22C	444	Grey
22D	444	Grey
22DD	444	Grey
22E	444	Grey
22F	444	Grey
22G	444	Grey
24B	164	Orange
24C	164	Orange
24D	164	Orange
24DD	164	Orange
24E	164	Orange
24F	164	Orange
24G	164	Orange
26C	230	Pink
26D	230	Pink
26DD	230	Pink
26E	230	Pink
26F	230	Pink
XS	318	Turquoise
S	347	Dark Green
M	185	Red
L	PB	Process Blue

CHILDRENSWEAR		
SIZE	PMS	COLOUR
tiny baby	396	Lime
new baby	318	Turquoise
0-3mths	347	Dark Green
3-6mths	164	Orange
6-12mths	264	Lilac
12-18mths	185	Red
18-24mths	121	Yellow
000000	BLK	Black
00000	396	Lime
0000	318	Turquoise
000	347	Dark Green
00	164	Orange
0	264	Lilac
1	185	Red
2	121	Yellow
3	230	Pink
4	359	Pale Green
5	154	Tan Brown
6	264	Lilac
7	444	Grey
8	185	Red
9	230	Pink
10	279	Dark Blue
12	347	Dark Green
14	318	Turquoise
16	154	Tan Brown
1/2	121	Yellow
2/3	230	Pink
3/4	359	Pale Green
4/6	264	Lilac
5/6	264	Lilac
6/8	185	Red
7/8	185	Red
8/10	279	Dark Blue
10/12	347	Dark Green
12/14	318	Turquoise
14/16	154	Tan Brown

MENSWEAR		
SIZE	PMS	COLOUR
XS	318	Turquoise
S	347	Dark Green
M	185	Red
L	PB	Proc Blue
XL	157	Brown
XXL	375	Bright Green
3XL - 4XL	154	Tan Brown
4XL - 5XL	150	Orange
5XL - 6XL	WHT	White
6XL - 7XL	444	Grey
7XL - 8XL	MAG	Magenta

# “CS” Size Clips Coloured

LADIESWEAR		
SIZE	PMS	COLOUR
6	506	Maroon
8	359	Pale Green
10	154	Tan Brown
12	185	Red
14	279	Dark Blue
16	264	Lilac
18	121	Yellow
20	347	Dark Green
22	444	Grey
24	164	Orange
26	230	Pink
28	264	Lilac
16+	264	Lilac
18+	121	Yellow
20+	347	Dark Green
22+	444	Grey
24+	164	Orange
26+	230	Pink
XXS	264	Lilac
XS	318	Turquoise
S	347	Dark Green
M	185	Red
L	PB	Proc Blue
XL	157	Brown
XXS/XS	318	Turquoise
S/M	185	Red
L/XL	157	Brown
XXL/XXXL	121	Yellow

MENSWEAR		
SIZE	PMS	COLOUR
36	PB	Proc Blue
38	318	Turquoise
40	185	Red
42	157	Brown
44	121	Yellow
46	150	Light Orange
30/77	318	Turquoise
32/82	347	Dark Green
34/87	185	Red
36/92	PB	Proc Blue
38/97	157	Brown
40/102	375	Bright Green
42/107	121	Yellow
XS	318	Turquoise
S	347	Dark Green
M	185	Red
L	PB	Proc Blue
XL	157	Brown
XXL	375	Bright Green
XXXL	121	Yellow
3XL	121	Yellow
4XL	154	Tan Brown
5XL	150	Light Orange
6XL	BLK	Black
7XL	444	Grey

# “NS” Size Clips

LADIESWEAR		
SIZE	PMS	COLOUR
8	359	Pale Green
10	154	Tan Brown
12	185	Red
14	279	Dark Blue
16	264	Lilac
18	121	Yellow
20	347	Dark Green

# “AC21” Size Clips Footwear

GENERAL		
SIZE	PMS	COLOUR
1	185	Red
2	154	Tan Brown
3	264	Lilac
4	359	Pale Green
5	230	Pink
6	157	Brown
6 1/2	157	Brown
7	444	Grey
7 1/2	444	Grey
8	164	Orange
8 1/2	164	Orange
9	318	Turquoise
9 1/2	318	Turquoise
10	PB	Proc Blue
11	347	Dark Green
12	279	Dark Blue
13	121	Yellow
14	264	Lilac
15	359	Pale Green
1/2	185	Red
2/3	154	Tan Brown
3/4	264	Lilac
4/5	359	Pale Green
5/6	230	Pink
6/7	157	Brown
7/8	444	Grey
8/9	164	Orange
9/10	318	Turquoise
10/11	PB	Proc Blue
11/12	347	Dark Green
12/13	279	Dark Blue
13/1	121	Yellow
S	347	Dark Green
M	185	Red
L	PB	Proc Blue
XL	157	Brown

# “ST” “CS” Clips Dannii Minogue

PLASTIC HOOK			METAL HOOK		
ST CLIPS			CS CLIPS		
SIZE	PMS	COLOUR	SIZE	PMS	COLOUR
4P	BLK	Black	4P	BLK	Black
6P	BLK	Black	6P	BLK	Black
8P	BLK	Black	8P	BLK	Black
10P	BLK	Black	10P	BLK	Black
12P	BLK	Black	12P	BLK	Black
14P	BLK	Black	14P	BLK	Black
16P	BLK	Black	16P	BLK	Black

# “ST” “CS” Clips Preview

## PLASTIC CLIPS

## METAL CLIPS

### ST CLIPS - LADIES

### CS CLIPS - LADIES

SIZE	PMS	COLOUR
6	SI	Silver
8	SI	Silver
10	SI	Silver
12	SI	Silver
14	SI	Silver
16	SI	Silver
18	SI	Silver
20	SI	Silver

SIZE	PMS	COLOUR
6	SI	Silver
8	SI	Silver
10	SI	Silver
12	SI	Silver
14	SI	Silver
16	SI	Silver
18	SI	Silver
20	SI	Silver

### ST CLIPS - MENS

### CS CLIPS - MENS

SIZE	PMS	COLOUR
30	SI	Silver
32	SI	Silver
34	SI	Silver
36	SI	Silver
38	SI	Silver
40	SI	Silver
42	SI	Silver
44	SI	Silver
46	SI	Silver
48	SI	Silver

SIZE	PMS	COLOUR
30	SI	Silver
32	SI	Silver
34	SI	Silver
36	SI	Silver
38	SI	Silver
40	SI	Silver
42	SI	Silver

### ST CLIPS - ALPHA

### CS CLIPS - ALPHA

SIZE	PMS	COLOUR
XXS/XS	SI	Silver
XS	SI	Silver
S	SI	Silver
S/M	SI	Silver
M	SI	Silver
L	SI	Silver
L/XL	SI	Silver
XL	SI	Silver
XXL	SI	Silver
XXL/XXXL	SI	Silver
XXXL	SI	Silver

SIZE	PMS	COLOUR
XXS/XS	SI	Silver
S/M	SI	Silver
L/XL	SI	Silver
XXL/XXXL	SI	Silver

# Pricing listing terms

## Notes

1. Payments prior to delivery (PPD) or 30 days from date of invoice to approved customers. Letter of Credit (LC) payment terms (where applicable) will be maximum 90 days
2. Bangladesh Prices are Ex-works or C&F Chittagong Port and are exclusive of any local taxes (if applicable)
3. Cambodia (Phnom Penh), Vietnam (Ho Chi Minh City) and Indonesia (Jakarta) Prices are C&F to port and are exclude any local taxes (if applicable)
4. India prices are US\$ C&F to Mumbai Nhava Sheva Port or Chennai Port) and exclude any local taxes (if applicable)
5. Prices are exclusive of any Letter of Credit fees, Bank Charges, Customs or Port Clearance Fees (where applicable)

6. All deliveries are in full carton / bag quantities

## Lead times

### AUSTRALIA:

From receipt of order despatch time in 2 business days

### CHINA / HONGKONG:

Despatch within 10 days from receipt of sales order / payment / customs document processing.

### BANGLADESH:

Orders are typically despatched within 15 business days ex-works from receipt of all documents.

Email: [hangers.bd@ticgroupasia.com](mailto:hangers.bd@ticgroupasia.com)

### CAMBODIA / VIETNAM & INDONESIA:

Despatch within 30 business days from receipt of all documents.

Email: [hangers.hk@ticgroupasia.com](mailto:hangers.hk@ticgroupasia.com)



# PACT Retail Accessories locations



## AUSTRALIA

232 Blackshaws Road  
Altona North Victoria 3015  
Ph: +613 9392 2343  
Fax: +613 9392 2332  
Email: [hangers.raau@pactgroup.com](mailto:hangers.raau@pactgroup.com)



## HONG KONG

Unit B, 1/F, Great Wall Factory Building,  
No. 11 Cheung Shun Street,  
Lai Chi Kok, Kowloon, Hong Kong  
Ph: +852 2148 3685  
Fax: +852 2148 3085  
Email: [hangers.hk@pactgroup.com](mailto:hangers.hk@pactgroup.com)



## SHANGHAI

Ningbo Xunxing Trade Co Ltd. –  
Shanghai Brand Office  
Unit E, 17/Floor, Hengji Plaza,  
No. 99 East Huaihai Road,  
Huangpu District, 200021  
Shanghai, China  
Ph: +86 21 6386 0808  
Fax: +86 21 6386 9533  
Email: [hangers.cn@pactgroup.com](mailto:hangers.cn@pactgroup.com)



## NINGBO WAREHOUSE

No 17, Xingye Zhong Road,  
East District of Free Trade Zone,  
Beilun, Ningbo, China  
Ph: +86 574 2687 3733  
Email: [hangers.cn@pactgroup.com](mailto:hangers.cn@pactgroup.com)



## BANGLADESH

755, Satmasjid Road,  
Green Rawshanara Tower,  
12th Floor Dhanmondi,  
Dhaka 1205, Bangladesh  
Contact: Md. Rafiquzzaman  
Phone: +880 1755528806  
PABX: +880 9611773344  
Email: [hangers.bd@pactgroup.com](mailto:hangers.bd@pactgroup.com)



## INDIA

Shop 3, 1st Floor, Solitaire Co-op Hsg. Soc.  
Anand Nagar, Near N L Complex,  
Dahisar (East), Mumbai – 400068. India  
Contact: Mr. Rudra Nadkarni  
Phone: +91 9819394017  
Email: [hangers.in@pactgroup.com](mailto:hangers.in@pactgroup.com)

# Thank You

---

## Pact Reuse Retail Accessories

232 Blackshaws Road

Altona North Vic 3025 Australia

ph: +61 3 9392 2343

Email: [hangers.raau@pactgroup.com](mailto:hangers.raau@pactgroup.com)

Web: [www.pactgroup.com/retail-accessories/](http://www.pactgroup.com/retail-accessories/)



RETAIL ACCESSORIES